

Model 3150 Downflow

Service Manual



IMPORTANT: Fill in pertinent information on page 2 for future reference.

MODEL 3150 Downflow

Job Specification Sheet

- JOB NO. _____
- *MODEL NO. _____
- WATER TEST _____
- CAPACITY PER UNIT _____
- MINERAL TANK SIZE DIA. _____ HEIGHT _____
- BRINE TANK SIZE & SALT SETTING PER REGENERATION: _____

* CONTROL VALVE SPECIFICATIONS

- 1) Type of Timer (see pages 16, 17, & 18)
 - A) 7 day or 12 day
 - B) * 1,250 to 21,250 gallon meter or
* 6,250 to 106,250 gallon meter or
* Other _____
 - C) Meter Wiring Package
 - 1) System #4 - 1 tank; 1 meter; immediate or delayed regeneration
 - 2) System #5 - 2 tanks; 2 meters; interlock
 - 3) System #6 - 2 tanks; 1 meter; series regeneration
 - 4) System #7 - 2 tanks; 1 meter; alternator
- 2) Timer Program Settings
 - A) Backwash _____ min.
 - B) Brine & Slow Rinse _____ min.
 - C) Rapid Rinse _____ min.
 - D) Brine Tank Refill _____ min.
- 3) Drain Line Flow Controller _____ gpm
- 4) Brine Line Flow Controller _____ gpm
- 5) Injector Size # _____
- 6) Service Valve Operation Units (SVO)
Size of Service Valve _____

MODEL 3150 Downflow

General Commercial Pre-Installation Check List

WATER PRESSURE: A minimum of 25 pounds of water pressure is required for regeneration valve to operate effectively.

ELECTRICAL FACILITIES: A continuous 115 volt, 60 Hertz current supply is required. (Other voltages available.) Make certain the current supply is always hot and cannot be turned off with another switch.

EXISTING PLUMBING: Condition of existing plumbing should be free from lime and iron buildup. Piping that is built up heavily with lime and/or iron should be replaced. If piping is clogged with iron, a separate iron filter unit should be installed ahead of the water softener.

LOCATION OF SOFTENER AND DRAIN: The softener should be located close to a drain.

BY-PASS VALVES: Always provide for the installation of a by-pass valve.

CAUTION: Water pressure is not to exceed 120 p.s.i., water temperature is not to exceed 100°F, and the unit cannot be subjected to freezing conditions.

INSTALLATION INSTRUCTIONS

1. Place the softener tank where you want to install the unit making sure the unit is level and on a firm base. (Maximum 7 feet apart for twin units.)
2. All plumbing should be done in accordance with local plumbing codes. The pipe size for the drain line should be the same size as the drain line flow control connection. Water meters are to be installed on soft water outlets. Twin units with (1) one meter shall be installed on common soft water outlet of units.
3. Make sure that the floor is clean beneath the salt storage tank and that it is level.
4. Place approximately 1" of water above the grid plate (if used) in your salt tank Salt may be placed in the unit at this time.
5. Place in by-pass position. Turn on the main water supply. Open a cold soft water tap nearby and let run a few minutes or until the system is free from foreign material (usually solder) that may have resulted from the installation.
6. Place the by-pass in service position.
7. Manually index the softener control into "service" position and let water flow into the mineral tank. When water flow stops, close inlet valve, place control in "backwash" position to relieve head of air, then gradually open inlet valve to purge remaining air in tank. Return control to "service" position.
8. Electrical: All electrical connections must be connected according to codes. Use electrical conduit if applicable. Plug into power supply.

MODEL 3150 Downflow

Water Conditioner Flow Diagrams

1 SERVICE POSITION

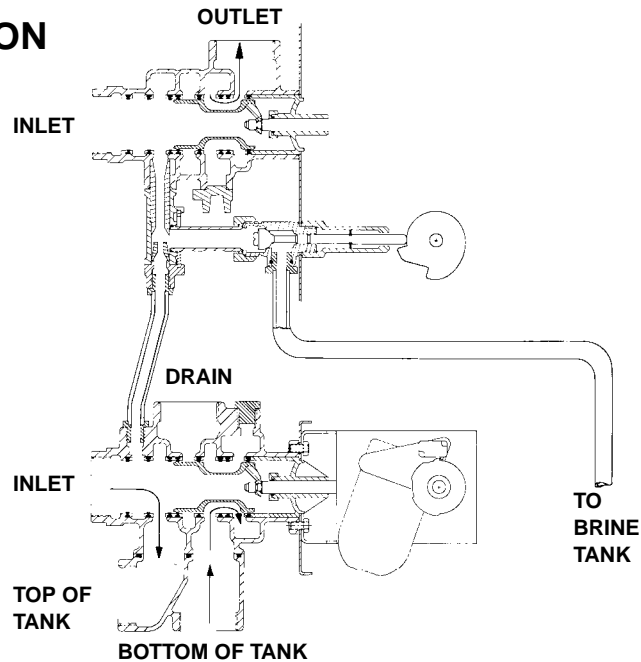

Hard water enters at valve inlet — flows thru valve to the top of tank — down thru mineral to the bottom distributor. Conditioned water flows to the valve, around the piston and out the outlet.

2 BACKWASH POSITION

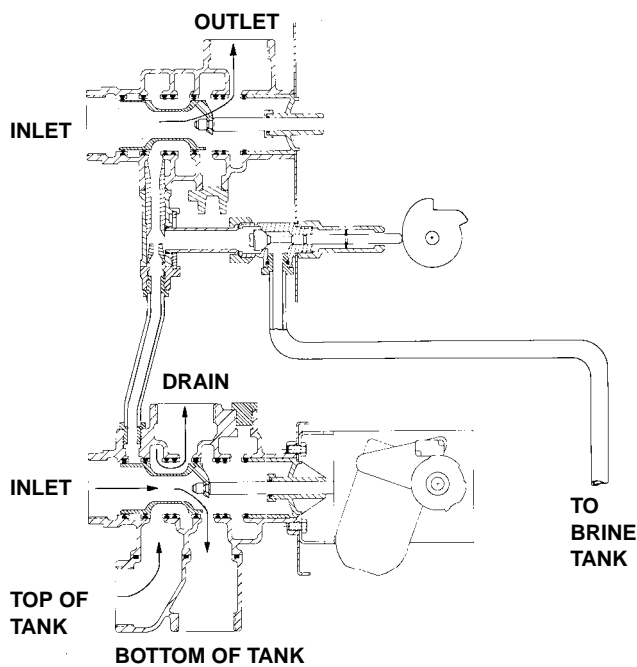

Hard water enters at valve inlet — flows thru valve to the bottom of tank — up thru mineral to top of tank, around the piston and out the drain. Hard water is also available at valve outlet.

3 BRINE AND SLOW RINSE POSITION

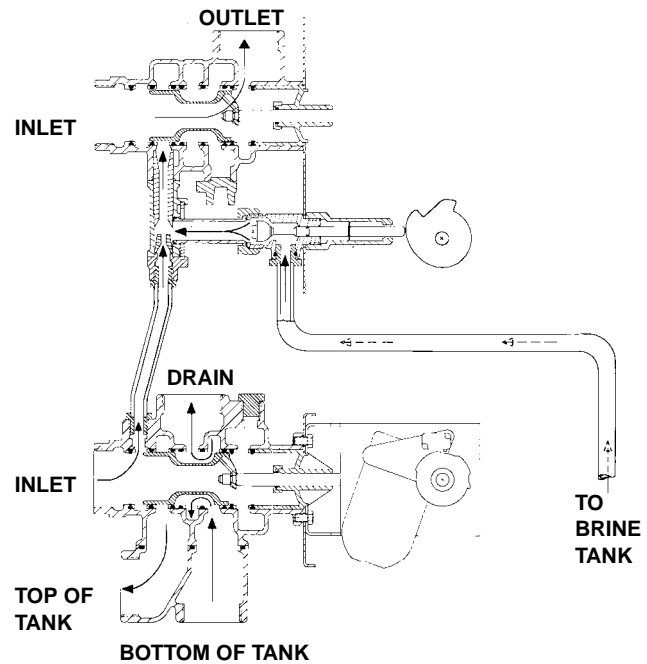

Hard water enters at valve inlet — flows thru injector nozzle and throat to draw brine from the brine tank — brine flows thru valve to the top of tank — down thru mineral to bottom distributor — back to the valve, around the piston and out the drain. Flow thru injectors continues for slow rinse for remainder of cycle. Hard water is also available at valve outlet.

MODEL 3150 Downflow

Water Conditioner Flow Diagrams (Cont'd.)

4 RAPID RINSE POSITION

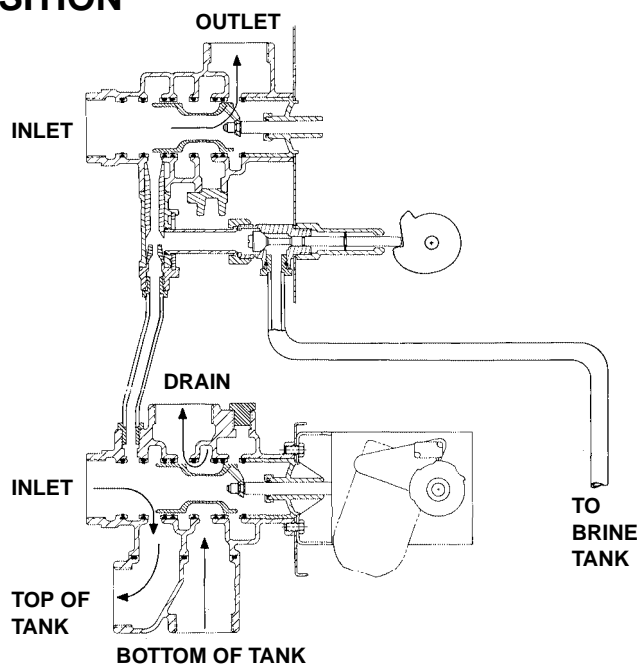

Hard water enters at valve inlet — flows thru valve to the top of tank — down thru mineral to bottom distributor — back to the valve, around the piston and out the drain. Hard water is also available at valve outlet.

5 BRINE TANK REFILL POSITION

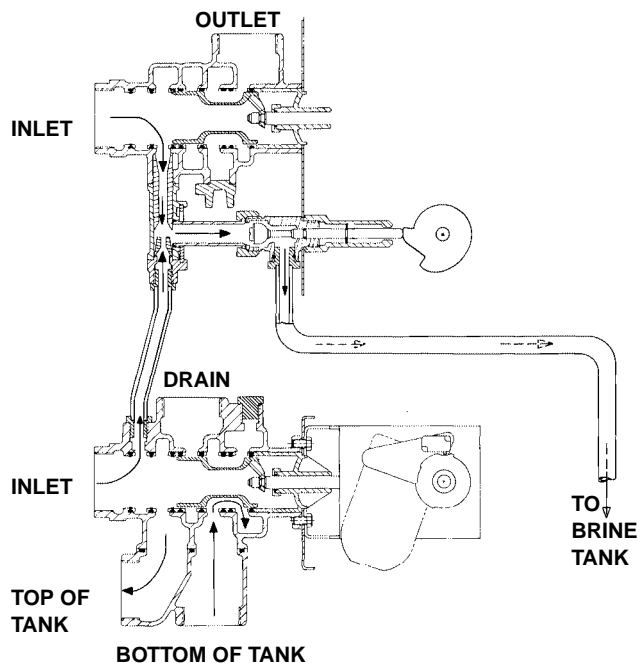

Hard water enters at valve inlet — flows thru nozzle and thru throat to brine valve to refill the brine tank. Conditioned water is also available at valve outlet during this cycle.

MODEL 3150 Downflow

Control Valve

(see opposite page for parts list)

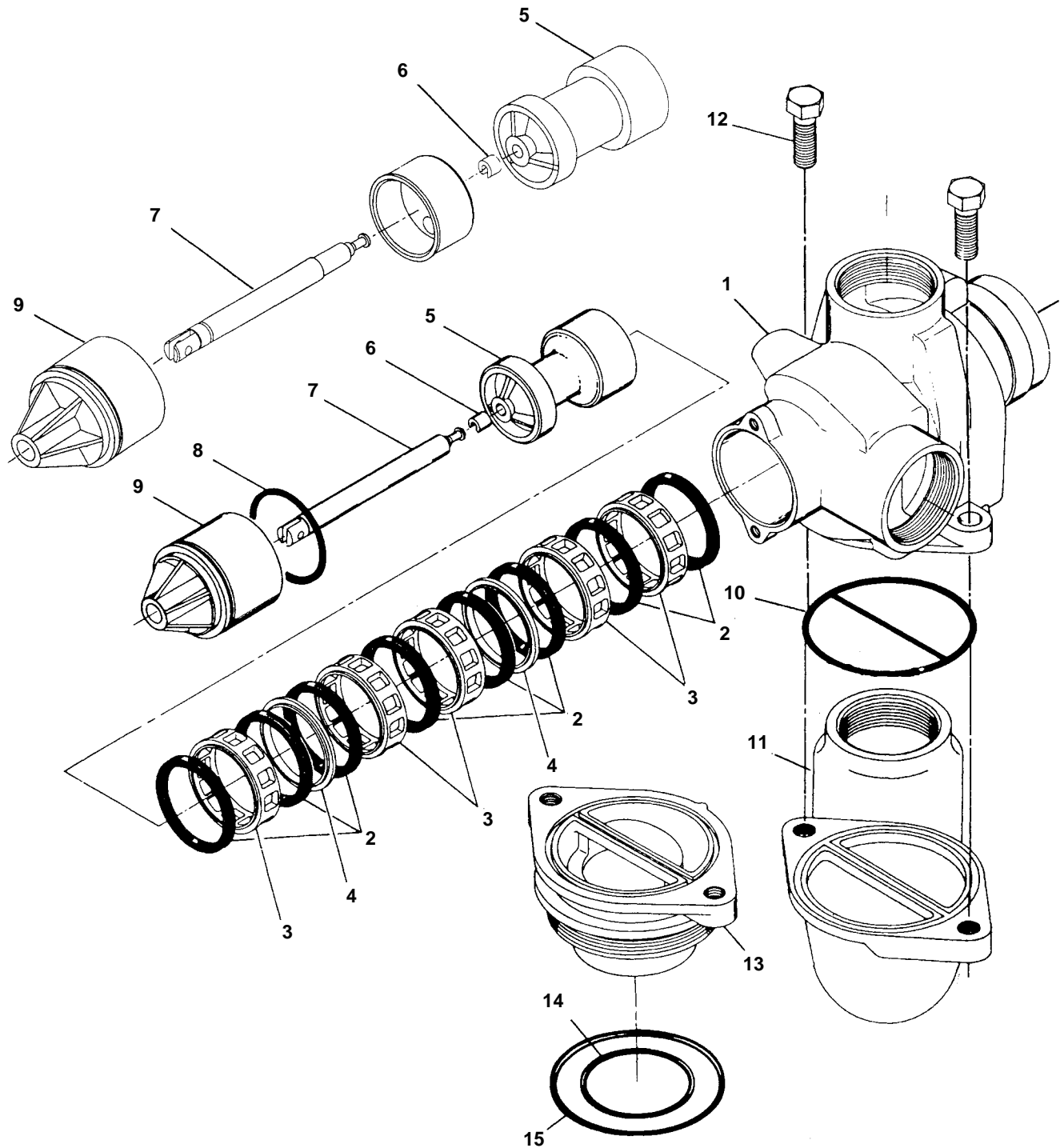

MODEL 3150 Downflow

Control Valve

Parts List

Item No.	Quantity	Part No.	Description
1.....	1	15114	Valve Body
2.....	8	11720	Seal
3.....	5	10369	Spacer - Port
	5	16141	Spacer - Port Hot Water
4.....	2	10368	Spacer
	2	10368-01	Spacer - Hot Water
5.....	1	16130	Piston
	1	19611-01	Piston Assy. NHWB-P
6.....	1	14818	Clip - Piston Rod
7.....	1	15125	Piston Rod
	1	19708	Piston Rod, NHWB-P
8.....	1	14922	O-Ring - 035
9.....	1	16398-01	End Plug Assembly
10.....	1	15112	Seal
11.....	1	17407	Adapter - Side Mount
12.....	2	40118	Screw - Hex Hd.
Options			
13.....	1	15117-01	Adapter - Top Mount 4" - 8 Th'd.
14.....	1	15247	O-Ring - 229 (Dist.)
15.....	1	13575	O-Ring - 240 (Tank)
	1	15210	O-Ring (Park Tank)
16.....	1	19608-20	Dispenser, Upper (Not shown)

MODEL 3150 Downflow

Control Drive Assembly

(see opposite page for parts list)

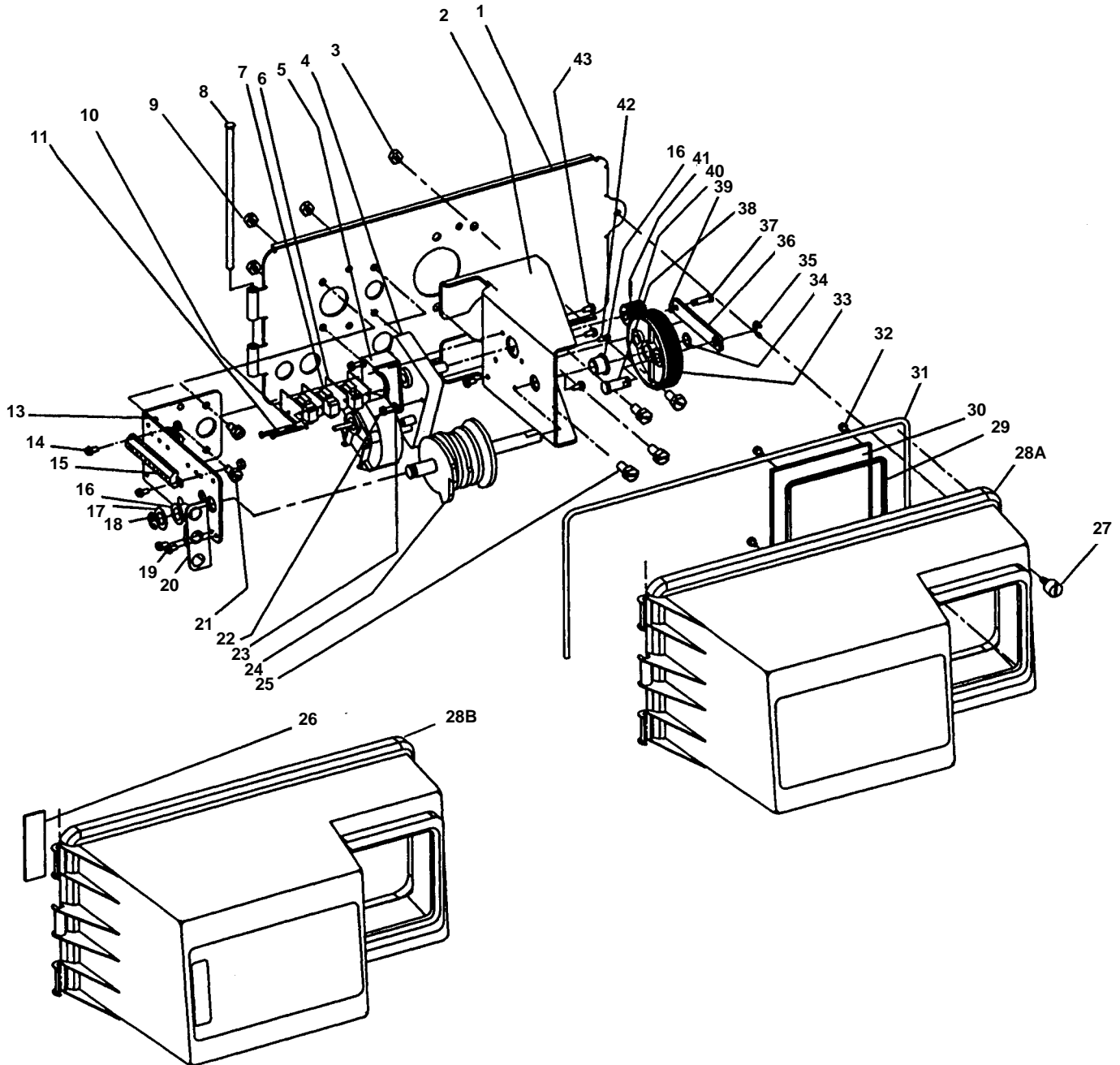

MODEL 3150 Downflow

Control Drive Assembly

Parts List

Item No.	Quantity	Part No.	Description
1	1	19304-00	Back Plate -01, -02
2	1	15120-01	Bracket - Motor Mounting
3	2	16346	Nut - 5/16-18
4	1	16044	Drive Motor - 11S V. 60 Hz.
		16500	Drive Motor - 220 V. 50 Hz.
		16501	Drive Motor - 24 V. 60 Hz.
5	1	17797	Bracket - Switch Mounting
6	4	10302	Insulator - Switch
7	3	10218	Switch
8	1	17845-03	Pin, Hinge
9	4	11235	Nut, 1/4-20
10	2	13365	Lockwasher
11	2	12624	Screw - Pan Hd.
13	1	16053	Bracket - Brine Side
14	2	40133	Screw - Round Hd.
15	1	15226-*	Terminal Block
16	2	16052	Bushing
17	1	16059	Washer
18	1	16051	Retaining Ring - Bowed "E"
•19	2	10300	Screw - Hex Hd. Thread Cutting
•20	1	19317	Light Bracket
21	4	10231	Screw - Hex Hd.
22	2	17567	Screw - Hex Hd.
23	2	12288	Washer, Lock, #8 Internal
24	1	16494-05	Cam Assembly - Service After RR
	1	16494-03	Cam Assembly - Service After Brine Refill
25	4	11224	Screw - Hex Hd.
•26	1	19319	Lamp Window
27	1	18744	Screw
28A	1	19277-020	Cover, Black
•28B	1	19277-021	Cover, Lamp Window
29	1	18615-02	Seal, Window
30	1	18745	Window
31	1	18716-03	Seal, Cover
32	4	19203	Screw
33	1	16046	Drive Gear
34	1	16050	Retaining Ring
35	1	11774	Retaining Ring "E"
36	1	16047	Drive Link
37	1	11709	Pin - Drive Link
38	1	16048	Bearing - Drive Link
39	1	11898	Clip
40	1	16045	Drive Pinion
41	1	11381	Roll Pin
42	1	11080	Screw - Flat Hd.
43	3	10872	Screw - Hex Hd.
44	1		Timer - (not shown) [3200, 3210, 3200E, 3200ET]
45	1	40084-07	Power Cord, 120V, 7FT (not shown)
	1	40084-12	Power Cord, 120V, 12FT (not shown)
	1	40085-07	Power Cord, 240V, 7FF (not shown)
46	1	17967	Strain Relief (not shown)
47	1	16430	Harness (not shown)
48	1	19691	Hole Plug - 3/4 Dia. (not shown)
49	1	19591	Hole Plug - 7/8 Dia. (not shown)
50	1	16427-04	Motor Lead Wire (not shown)
51	1	16384	Wire Harness (not shown)
52	1	14924	Strain Relief (not shown)
53	1	15513	Meter Cable (not shown)
54	2	15250	Label - Terminal Strip (not shown)
55	1	16827	Cable Guide Assembly (not shown)

* Specify number of terminals
• Optional Parts for Lamp Package

MODEL 3150 Downflow

1800 Series Brine System Assembly

(see opposite page for parts list)

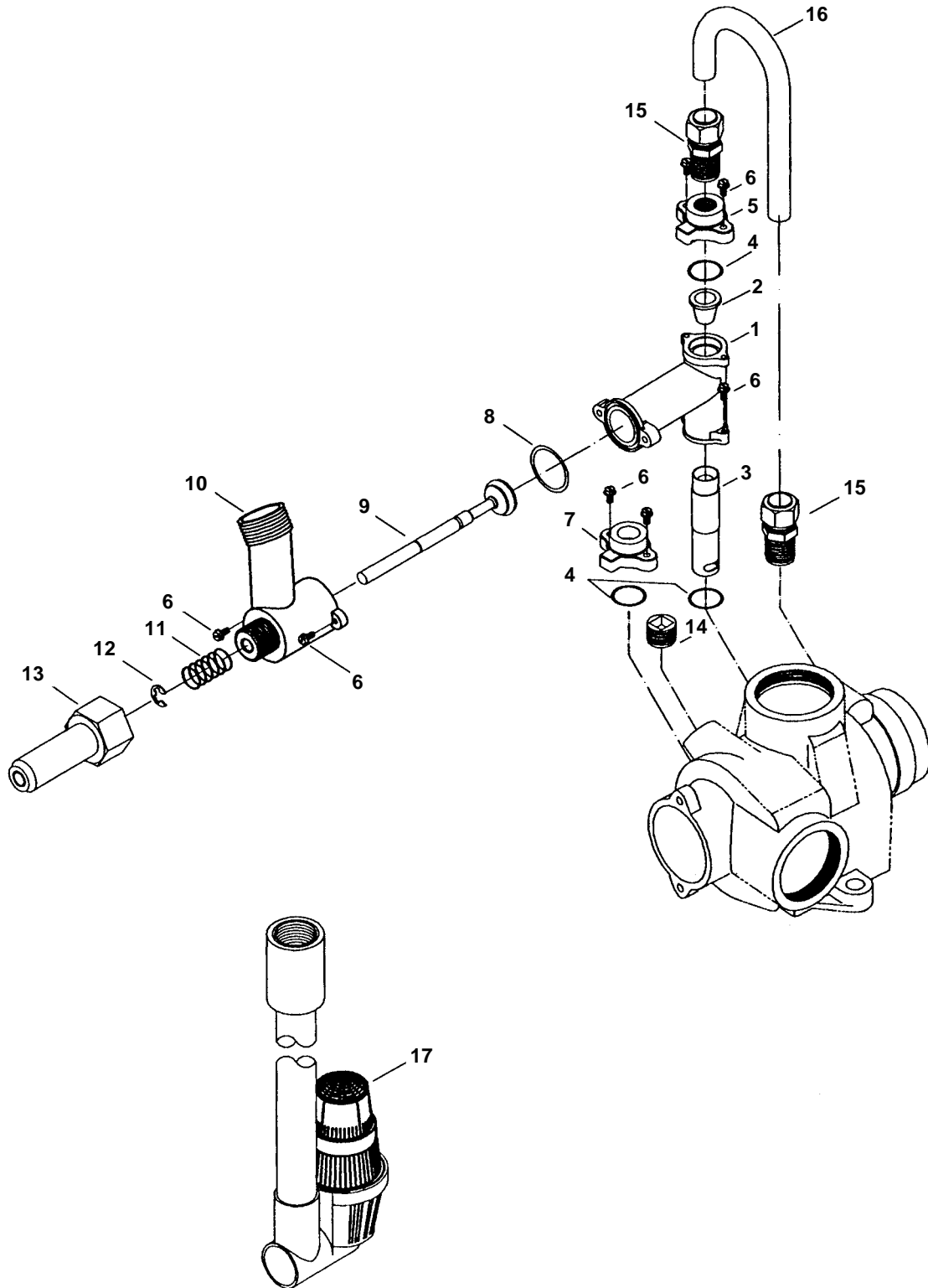

MODEL 3150 Downflow

1800 Series Brine System Assembly

Parts List

Item No.	Quantity	Part No.	Description
1	1	16340	Injector Body
2	1	15128-*	Injector Nozzle
3	1	15127-*	Injector Throat
4	3	15246	O-Ring - 116
5	1	16341-01	Injector Cover
6	8	12473	Screw - Hex Hd.
7	1	16341-02	Cover
8	1	18879	O-Ring - 021
9	1	16497-01	Brine Stem Assembly
10	1	18713	Brine Valve Body
11	1	11772	Spring
12	1	11774	Retaining Ring
13	1	16498-01	Stem Guide Assembly
14	1	16387	Pipe Plug - 1/2 NPT
15	2	18702	Tube Fitting - Straight
16	1	18703	Brine Tube
17	1	60009	#900 Commercial Air Check
	1	60009-01	#900 Commercial Air Check Hot Water
18	1		Flow Control - Specify Flow Rate - Not Shown

* Specify size

Option Without Brine Valve

1	16605	Retainer Plate
1	16620	Fitting - Brine Tank
1	18879	O-Ring - 021

Delete: Items 9 thru 16

Injector Throat

15127-04	#4	Green
15127-05	#5	Red
15127-06	#6	White
15127-07	#7	Blue
15127-08	#8	Yellow
15127-09	#9	Violet
15127-10	#10	Black

Injector Nozzle

	Size	Color
15128-04	#4	Green
15128-05	#5	Red
15128-06	#6	White
15128-07	#7	Blue
15128-08	#8	Yellow
15128-09	#9	Violet
15128-10	#10	Black

MODEL 3150 Downflow

Service Valve Operator

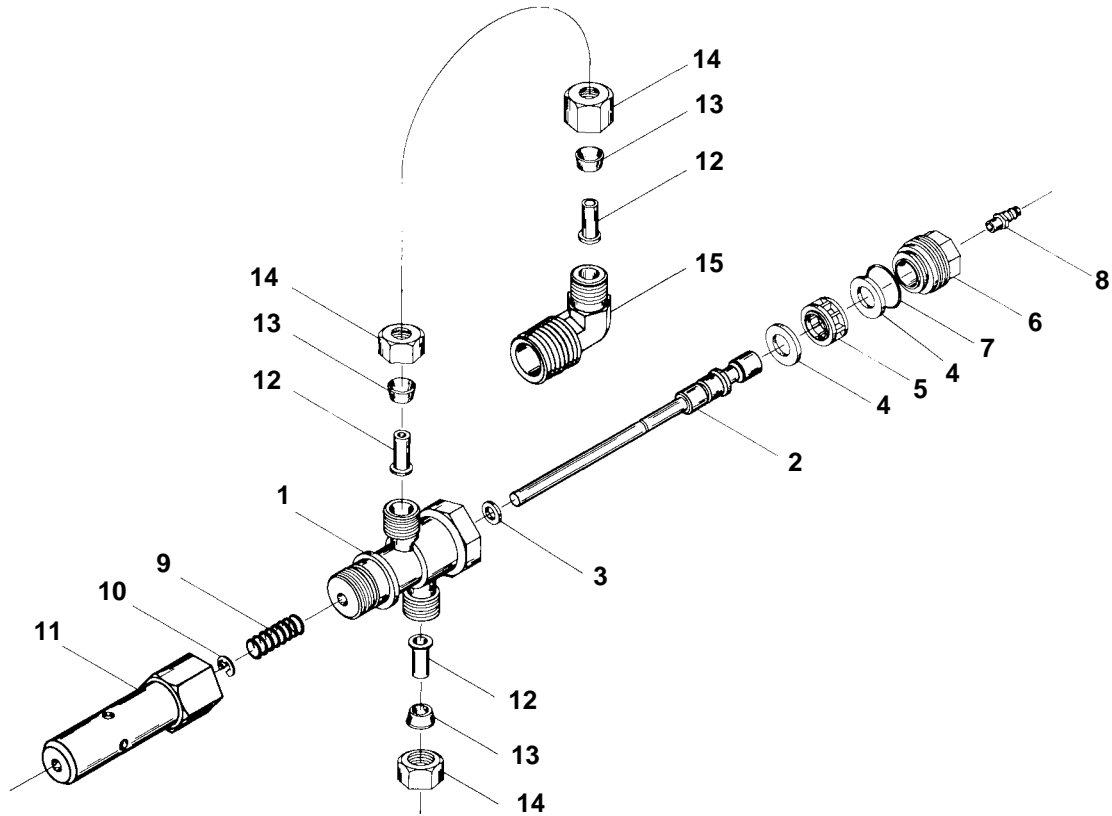

PARTS LIST

Item No.	Quantity	Part No.	Description
1	1	15074	Valve Body
2	1	16065	Stem
3	1	10141	O-Ring - 010
4	2	14835	Seal
5	1	14834	Spacer
6	1	16509	End Plug
7	1	14516	O-Ring - 015
8	1	15965	Fitting - 1/4 Tube
9	1	10249	Spring
10	1	10250	Retaining Ring
11	1	16498-02	Stem Guide Assembly
12	3	10332	Insert
13	3	10330	Ferrule
14	3	10329	Nut
15	1	16503	Tube Fitting
16	1	16511	SVO Tube - Not Shown

MODEL 3150 ECONOMINDER™

2" Meter Assembly

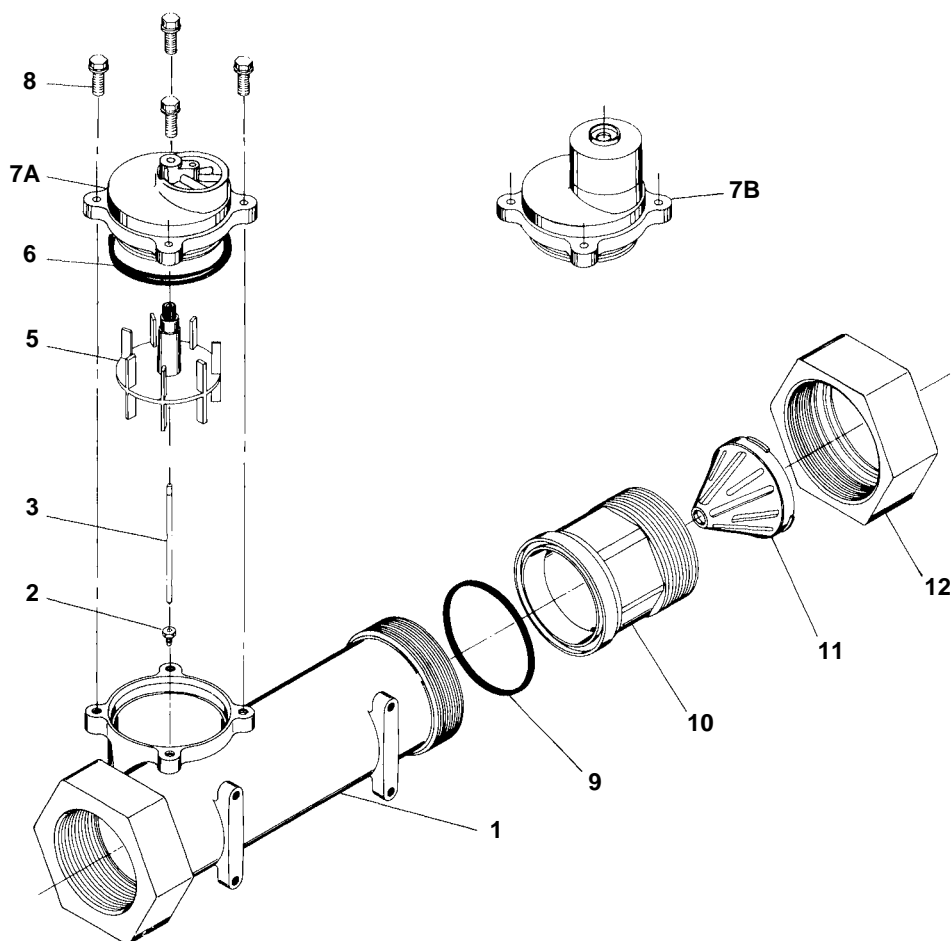

PARTS LIST

Item No.	Quantity	Part No.	Description
1	1	14456	Meter Body
2	1	15532	Impeller Shaft Retainer
3	1	15432	Impeller Shaft
4			Not Assigned
5	1	15374	Impeller
6	1	13847	O-Ring - Meter Cover
7A	1	15218	Meter Cover Assembly (Standard)
7B	1	15237	Meter Cover Assembly (Extended Range)
8	4	12112	Screw - Meter Cover
9	1	14679	O-Ring - Quick Connect
10	1	14568	Nipple - Quick Connect
11	1	14680	Flow Straightener
12	1	14569	Nut - Quick Connect

MODEL 3210 ECONOMINDER™

Timer Assembly

(see opposite page for parts list)

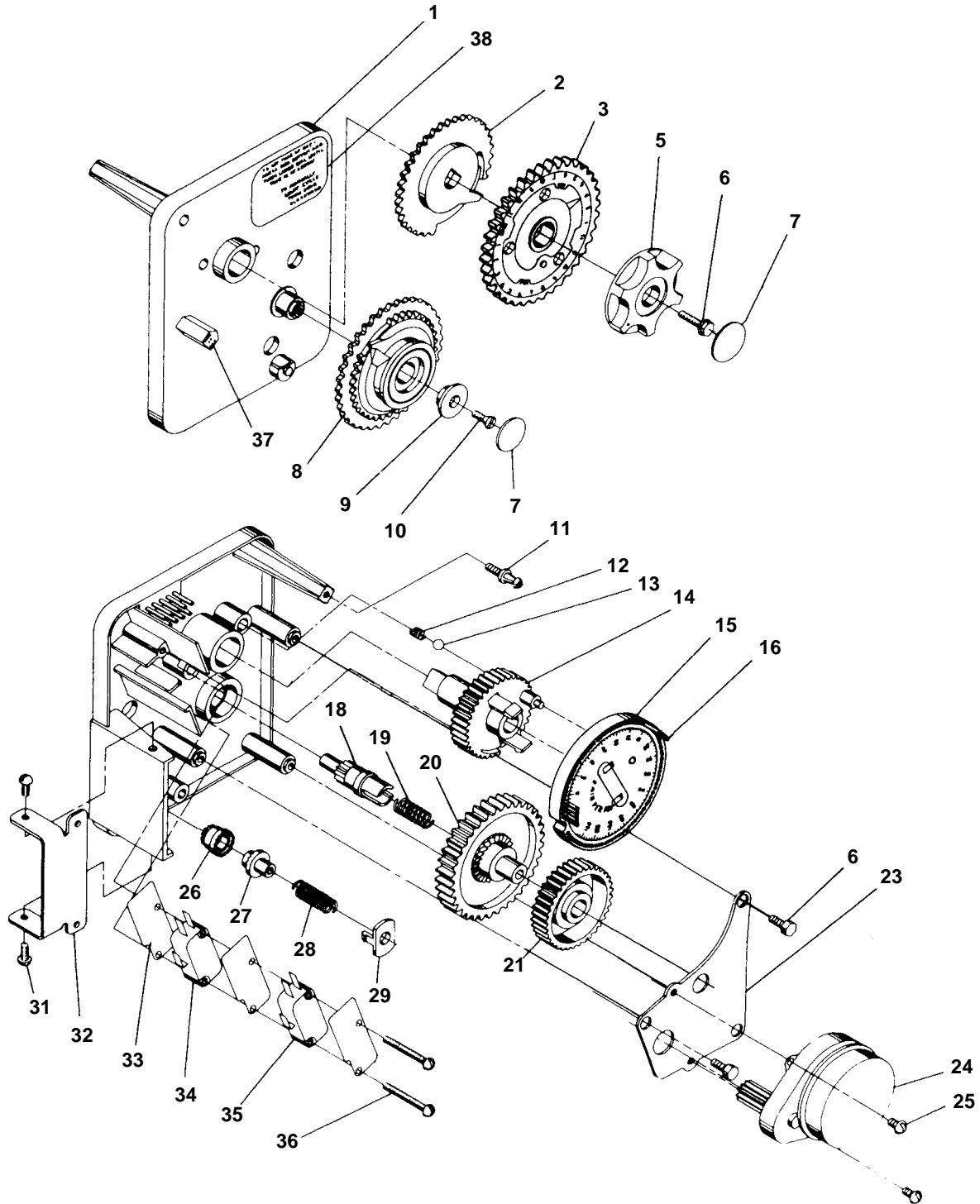

MODEL 3210 ECONOMINDER™

Timer Assembly

Parts List

Item No.	Quantity	Part No.	Description
1	1	13870-01	Timer Housing Assembly
2	1	13802	Cycle Actuator Gear
3	1	40096-27	24 Hour Gear Assy, 12 Midnight
		40096-02	24 Hour Gear Assy, 2 AM
5	1	13886-01	Knob
6	4	13296	Screw - Timer Knob & Motor Plate Mtg.
7	2	11999	Button Decal
8	1	60405-50	Program Wheel Assembly, 21,000
9	1	13806	Program Wheel Retainer
10	1	13748	Screw - Program Wheel Mtg.
11	1	14265	Spring Clip
12	1	15424	Spring - Detent
13	1	15066	Ball - 1/4" Dia.
14	1	13911	Main Drive Gear
15	1	19210	Program Wheel
16	21	15493	Roll Pin
18	1	13018	Idler Shaft
19	1	13312	Spring - Idler
20	1	13017	Idler Gear
21	1	13164	Drive Gear
23	1	13887	Motor Mounting Plate
24	1	18743	Motor - 110V., 60 Hz.
		19659	Motor - 24V., 60 Hz.
25	2	13278	Screw - Motor Mounting
26	1	13830	Drive Pinion - Program Wheel
27	1	13831	Clutch - Drive Pinion
28	1	14276	Spring
29	1	14253	Spring Retainer
30			Not Assigned
31	3	11384	Screw - Timer Hinge & Ground Wire
32	1	13881	Hinge Bracket
33	3	14087	Insulator
34	1	10896	Switch
35	1	15320	Switch
36	2	11413	Screw - Switch Mounting
37	1	14007	Decal - Time of Day
38	1	14045	Decal - Instructions
39	1	13902	Harness - Not Shown
40	2	12681	Wire Connector - Not Shown
41	1	15354-01	Ground Wire - Not Shown
Not Shown	1	15465	Caution Label
Not Shown	1	14198	Capacity Label

MODEL 3210 ECONOMINDER™

Commercial Demand Regeneration Control

Timer Settings

Typical Programming Procedure

Calculate the gallon capacity of the system, subtract the necessary reserve requirement and set the gallons required by lifting the gallon dial and rotating it so that the number of gallons required is aligned with the white dot on program wheel gear. Release and check for firm engagement with gear. Note, drawing shows 8,750 gallon setting. The capacity (gallons) arrow denotes remaining gallons exclusive of fixed reserve.

Note:

To set meter capacity at initial start-up, either:

1. Rotate manual regeneration knob one full revolution.
— or —
2. Rotate program wheel manually clockwise or counter clockwise and align white dot with capacity arrow.

This procedure must be followed any time the program wheel setting is changed.

How To Set The Time Of Day:

Press and hold the red button in to disengage the 24 hour gear.

Turn the 24 hour gear until the actual time of day is at the time of day pointer.

Release the red button to again engage the 24 hour gear.

How To Manually Regenerate Your Water Conditioner At Any Time:

Turn the manual regeneration knob clockwise one "click."

This slight movement of the manual regeneration knob engages the program wheel and starts the regeneration program.

The black center knob will make one revolution in the following approximately three hours and stop in the position shown in the drawing.

Even though it takes three hours for this center knob to complete one revolution, the regeneration cycle of your unit might be set for only one half of this time.

In any event, conditioned water may be drawn after rinse water stops flowing from the water conditioner drain line.

Immediate Regeneration Timers:

These timers do not have a 24 hour gear. Setting the gallons on the program wheel and manual regeneration procedure are the same as previous instructions.

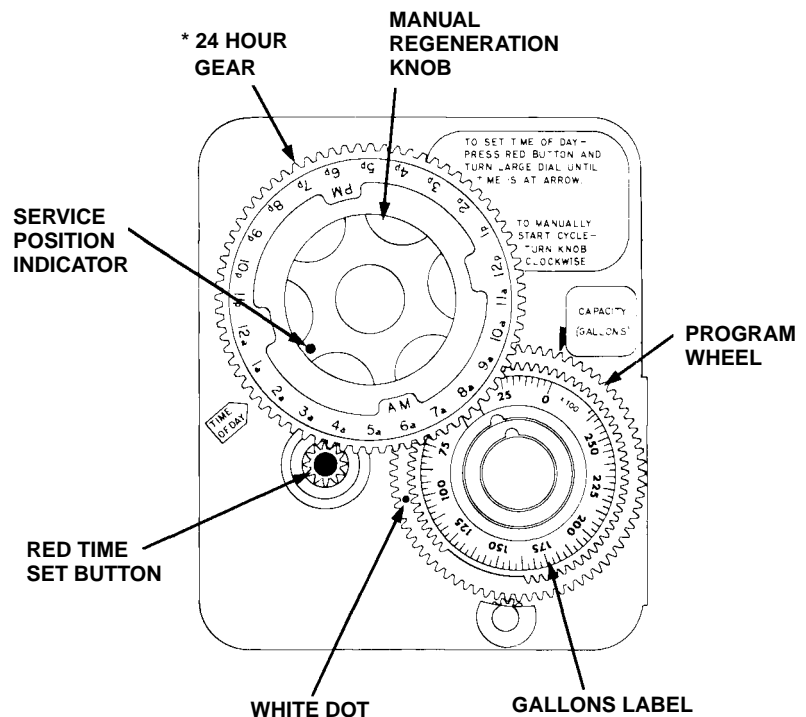

* Immediate regeneration timers do not have 24 hour gear. No time of day can be set.

MODEL 3200 TIMER

Timer Setting Procedure

How To Set Days On Which Water Conditioner Is To Regenerate:

Rotate the skipper wheel until the number "1" is at the red pointer. Set the days that regeneration is to occur by sliding tabs on the skipper wheel outward to expose trip fingers. Each tab is one day. Finger at red pointer is tonight. Moving clockwise from the red pointer, extend or retract fingers to obtain the desired regeneration schedule.

How To Set The Time Of Day:

Press and hold the red button in to disengage the drive gear. Turn the large gear until the actual time of day is at the time of day pointer.

Release the red button to again engage the drive gear.

How To Manually Regenerate Your Water Conditioner At Any Time:

Turn the manual regeneration knob clockwise.

This slight movement of the manual regeneration knob engages the program wheel and starts the regeneration program.

The black center knob will make one revolution in the following approximately three hours and stop in the position shown in the drawing.

Even though it takes three hours for this center knob to complete one revolution, the regeneration cycle of your unit might be set only one half of this time.

In any event, conditioned water may be drawn after rinse water stops flowing from the water conditioner drain line.

How to Adjust Regeneration Time:

1. Disconnect the power source.
2. Locate the three screws behind the manual regeneration knob by pushing the red button in and rotating the 24 hour dial until each screw appears in the cut out portion of the manual regeneration knob.
3. Loosen each screw slightly to release the pressure on the time plate from the 24 hour gear.
4. Locate the regeneration time pointer on the inside of the 24 hour dial in the cut out.
5. Turn the time plate so the desired regeneration time aligns next to the raised arrow.
6. Push the red button in and rotate the 24 hour dial. Tighten each of the three screws.
7. Push the red button and locate the pointer one more time to ensure the desired regeneration time is correct.
8. Reset the time of day and restore power to the unit.

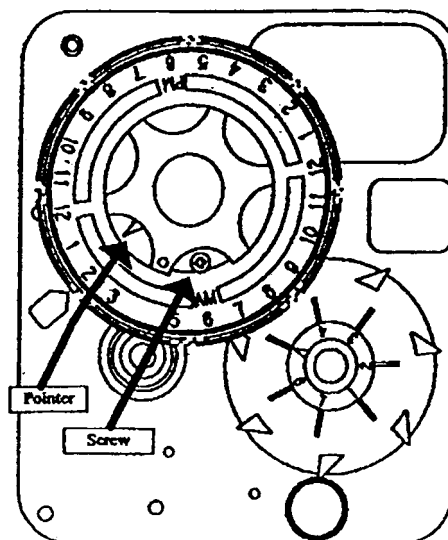
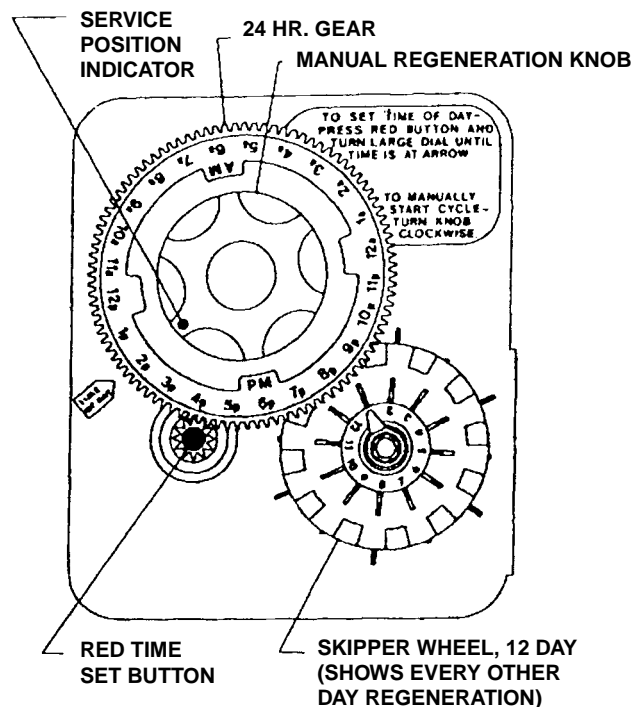

3200 ADJUSTABLE REGENERATION TIMER

IMPORTANT!

SALT LEVEL MUST ALWAYS BE ABOVE WATER LEVEL IN BRINE TANK

MODEL 3200 & 3210 TIMER SERIES

Regeneration Cycle Program Setting Procedure

How To Set Regeneration Cycle Program:

The regeneration cycle program on your water conditioner has been factory preset, however, portions of the cycle or program may be lengthened or shortened in time to suit local conditions.

3200 & 3210 Series Timers (Figure to Right)

To expose cycle program wheel, grasp timer in upper left-hand corner and pull, releasing snap retainer and swinging timer to the right.

To change the regeneration cycle program, the program wheel must be removed. Grasp program wheel and squeeze protruding lugs toward center, lift program wheel off timer. (Switch arms may require movement to facilitate removal.)

Return timer to closed position engaging snap retainer in back plate. Make certain all electrical wires locate above snap retainer post.

Timer Setting Procedure for 3200 & 3210 Timer

How To Change The Length Of The Backwash Time:

The program wheel as shown in the drawing is in the service position. As you look at the numbered side of the program wheel, the group of pins starting at zero determines the length of time your unit will backwash.

FOR EXAMPLE: If there are six pins in this section, the time of backwash will be 12 min. (2 min. per pin). To change the length of backwash time, add or remove pins as required. The number of pins times two equal the backwash time in minutes.

How To Change The Length Of Brine And Rinse Time:

The group of holes between the last pin in the backwash section and the second group of pins determines the length of time that your unit will brine and rinse (2 min. per hole).

To change the length of brine and rinse time, move the rapid rinse group of pins to give more or fewer holes in the brine and rinse section. Number of holes times two equals brine and rinse time in minutes.

How To Change The Length Of Rapid Rinse:

The second group of pins on the program wheel determines the length of time that your water conditioner will rapid rinse (2 min. per pin).

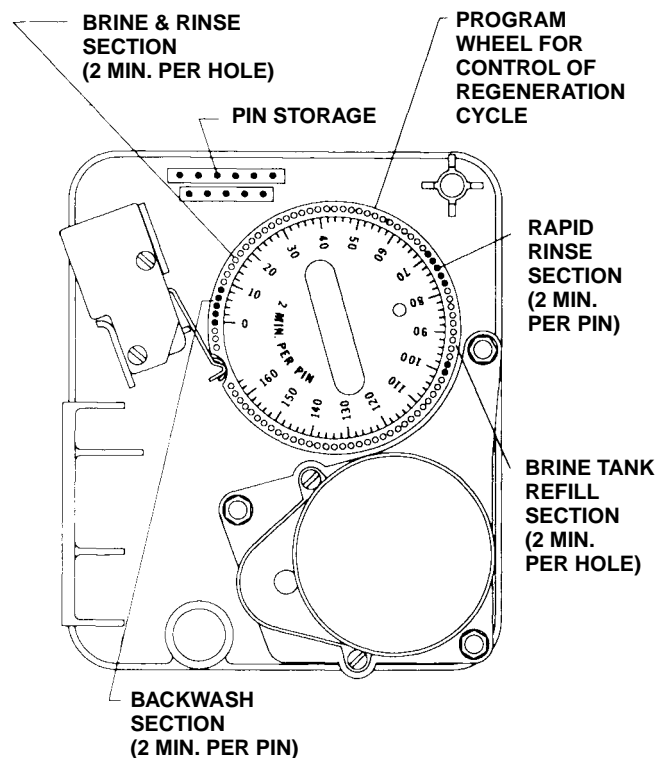

To change the length of rapid rinse time, add or remove pins at the higher numbered end of this section as required. The number of pins times two equals the rapid rinse time in minutes.

How To Change The Length Of Brine Tank Refill Time:

The second group of holes in the program wheel determines the length of time that your water conditioner will refill the brine tank (2 min. per hole).

To change the length of refill time, move the two pins at the end of the second group of holes as required.

The regeneration cycle is complete when the outer microswitch is tripped by the two pin set at end of the brine tank refill section. The program wheel, however, will continue to rotate until the inner microswitch drops into the notch on the program wheel.

MODEL 3150 Downflow

Service Instructions

PROBLEM	CAUSE	CORRECTION
1. Softener fails to regenerate.	A. Electrical service to unit has been interrupted. B. Timer is defective. C. Power failure.	A. Assure permanent electrical service (check fuse, plug, pull chain or switch). B. Replace timer. C. Reset time of day.
2. Hard water.	A. By-pass valve is open. B. No salt in brine tank. C. Insufficient water flowing into brine tank. D. Hot water tank hardness. E. Leak at distributor tube. F. Internal valve leak.	A. Close by-pass valve. B. Add Salt to brine tank and maintain salt level above water level. C. Check brine tank fill time and clean brine line flow control if plugged. D. Repeated flushing of the hot water tank is required. E. Make sure distributor tube is not cracked. Check O-ring and tube pilot. F. Replace seals and spacers and/or piston.
3. Unit used too much salt	A. Improper salt setting. B. Excessive water in brine tank.	A. Check salt usage and salt setting. B. See Problem No. 7.
4. Loss of water pressure.	A. Iron buildup in line to water conditioner. B. Iron buildup in water conditioner. C. Inlet of control plugged due to foreign material broken loose from pipe by recent work done on plumbing system.	A. Clean line to water conditioner. B. Clean control and add mineral cleaner to mineral bed. Increase frequency of regeneration. C. Remove pistons and clean control.
5. Loss of mineral through drain line.	A. Air in water system. b. Improperly sized drain line flow control.	A. Assure that well system has proper air eliminator control. Check for dry well condition. B. Check for proper drain rate.
6. Iron in conditioned water.	A. Fouled mineral bed.	A. Check backwash, brine draw and brine tank fill. Increase frequency of regeneration. Increase backwash time.

MODEL 3150 Downflow

PROBLEM	CAUSE	CORRECTION
7. Excessive water in brine tank	<ul style="list-style-type: none"> A. Plugged drain line flow control. B. Plugged injector system. C. Timer not cycling. D. Foreign material in brine valve. E. Foreign material in brine line flow control. 	<ul style="list-style-type: none"> A. Check flow control. B. Clean injector and screen. C. Replace timer. D. Replace brine valve seat and clean valve. E. Clean brine line flow control.
8. Softener fails to draw brine.	<ul style="list-style-type: none"> A. Drain line flow control is plugged. B. Injector is plugged. C. Line pressure is too low. D. Internal Control Leak. 	<ul style="list-style-type: none"> A. Clean drain line flow control. B. Clean injector. C. Increase line pressure to 25 P.S.I. min. D. Check drive motor and switches.
9. Control cycles continuously.	<ul style="list-style-type: none"> A. Missadjusted, broken or shorted switch. 	<ul style="list-style-type: none"> A. Determine if switch or timer is faulty and replace it, or replace complete power head.
10. Drain flows continuously.	<ul style="list-style-type: none"> A. Valve is not programming correctly. B. Foreign material in control. C. Internal control leak 	<ul style="list-style-type: none"> A. Check timer program and positioning of control. Replace power head assembly if not positioning properly. B. Remove power head assembly and inspect bore, remove foreign material and check control in various regeneration positions. C. Replace seals and piston assembly.

General Service Hints

Problem: Softener Delivers Hard Water.

Cause could be that . . . Reserve Capacity Has Been Exceeded.

Correction: Check salt dosage requirements and reset program wheel to provide additional reserve.

Cause could be that . . . Program Wheel Is Not Rotating With Meter Output.

Correction: Pull cable out of meter cover and rotate manually. Program wheel must move without binding and clutch must give positive "clicks" when program wheel strikes regeneration stop. If it does not, replace timer.

Cause could be that . . . Meter Is Not Measuring Flow.

Correction: Check meter with meter checker.

3150 System #4

Valve Wiring

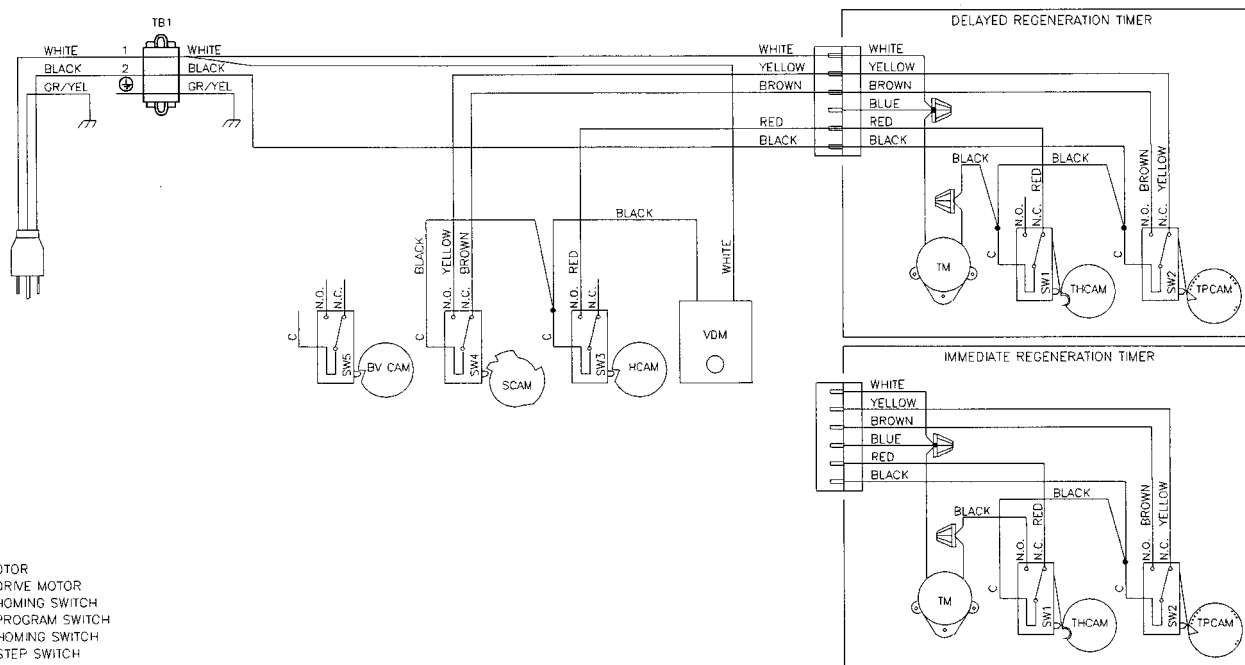

- TM - TIMER MOTOR
- VDM - VALVE DRIVE MOTOR
- SW1 - TIMER HOMING SWITCH
- SW2 - TIMER PROGRAM SWITCH
- SW3 - VALVE HOMING SWITCH
- SW4 - VALVE STEP SWITCH
- SW4 - BRINE CAM SWITCH
- THCAM - TIMER HOMING CAM
- TPCAM - TIMER PROGRAM CAM
- HCAM - VALVE HOMING CAM
- SCAM - VALVE STEP CAM
- BVCAM - BRINE VALVE CAM

NOTE:
SINGLE TANK TIMECLOCK, METER DELAYED, OR METER IMMEDIATE REGENERATION

3150 System #4 With Remote Meter

Valve Wiring

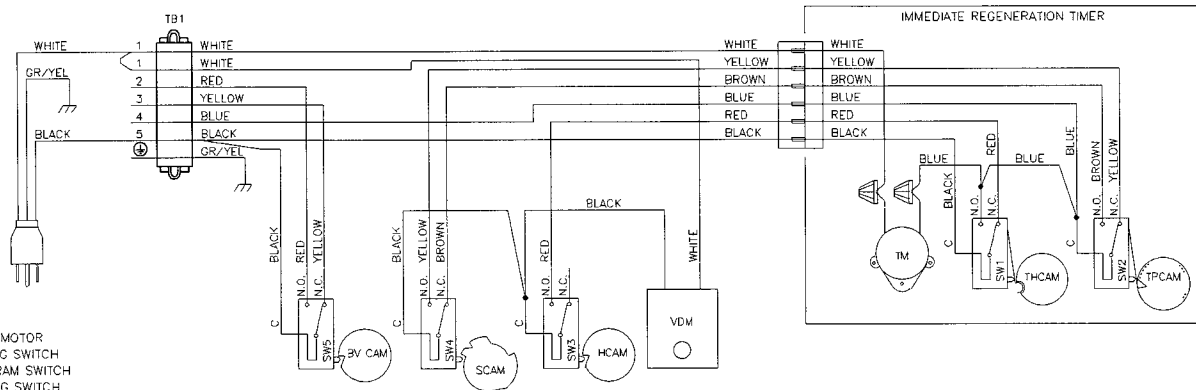

- TM - TIMER MOTOR
- VDM - VALVE DRIVE MOTOR
- SW1 - TIMER HOMING SWITCH
- SW2 - TIMER PROGRAM SWITCH
- SW3 - VALVE HOMING SWITCH
- SW4 - VALVE STEP SWITCH
- SW5 - BRINE CAM SWITCH
- THCAM - TIMER HOMING CAM
- TPCAM - TIMER PROGRAM CAM
- HCAM - VALVE HOMING CAM
- SCAM - VALVE STEP CAM
- BVCAM - BRINE VALVE CAM

NOTE:
SINGLE TANK REMOTE METER INITIATED DELAYED, OR IMMEDIATE REGENERATION

REMOTE METER WIRING

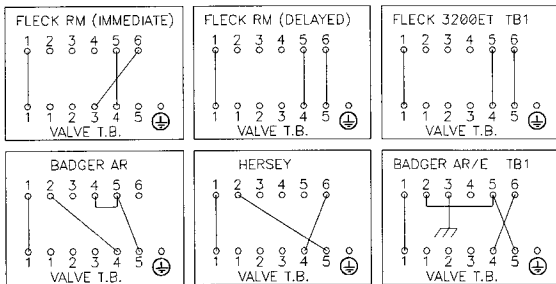

3150 System #5

Valve Wiring

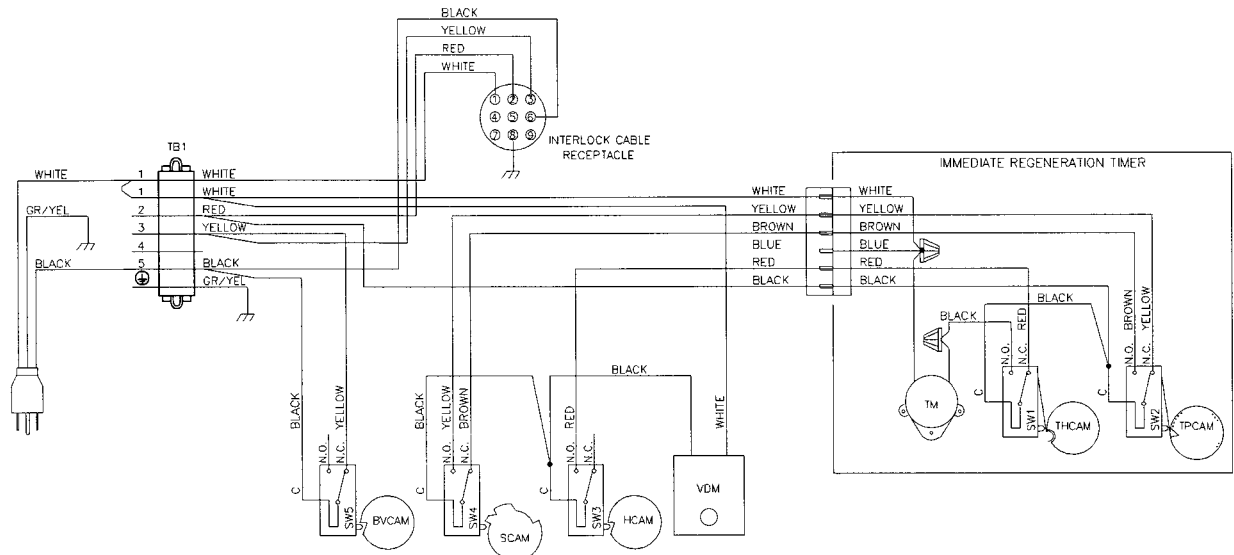

- TM - TIMER MOTOR
- VDM - VALVE DRIVE MOTOR
- SW1 - TIMER HOMING SWITCH
- SW2 - TIMER PROGRAM SWITCH
- SW3 - VALVE HOMING SWITCH
- SW4 - VALVE STEP SWITCH
- SW5 - BRINE CAM SWITCH
- THCAM - TIMER HOMING CAM
- TPCAM - TIMER PROGRAM CAM
- HCAM - VALVE HOMING CAM
- SCAM - VALVE STEP CAM
- BVCAM - BRINE VALVE CAM

NOTE:
TWO TANK INTERLOCKED INDIVIDUAL METER IMMEDIATE REGENERATION.
ONLY ONE TANK IN REGENERATION THE OTHER IN SERVICE.

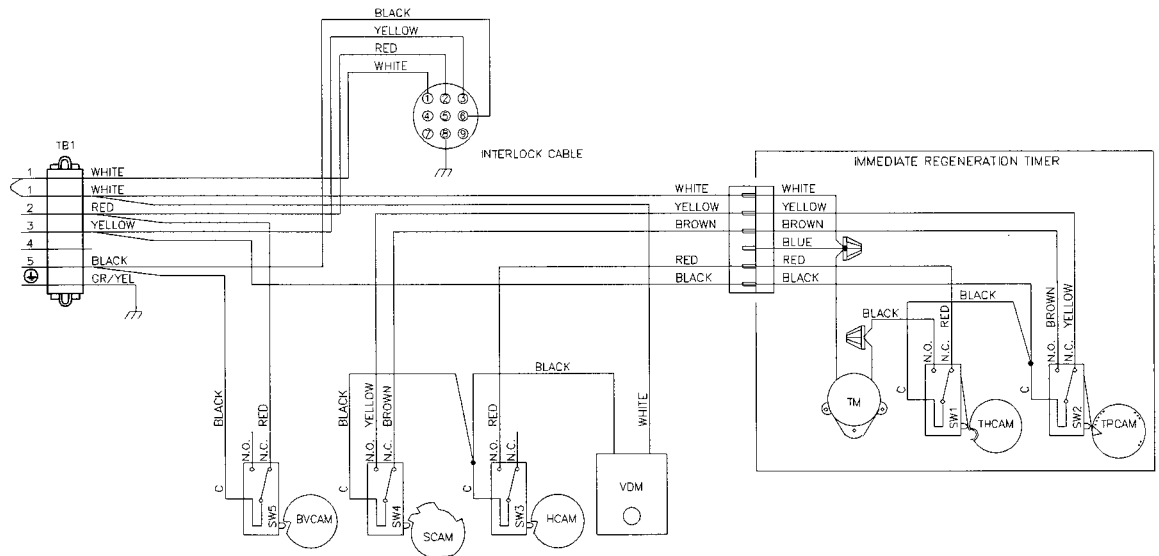

- TM - TIMER MOTOR
- VDM - VALVE DRIVE MOTOR
- SW1 - TIMER HOMING SWITCH
- SW2 - TIMER PROGRAM SWITCH
- SW3 - VALVE HOMING SWITCH
- SW4 - VALVE STEP SWITCH
- SW5 - BRINE CAM SWITCH
- THCAM - TIMER HOMING CAM
- TPCAM - TIMER PROGRAM CAM
- HCAM - VALVE HOMING CAM
- SCAM - VALVE STEP CAM
- BVCAM - BRINE VALVE CAM

3150 System #6

Valve Wiring

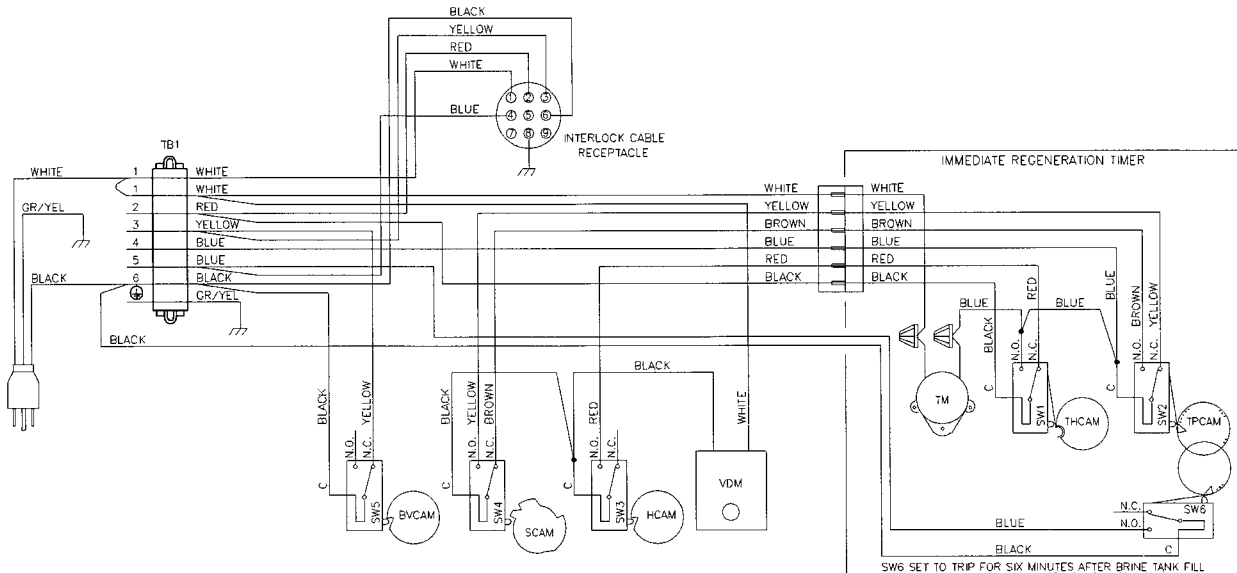

- TM - TIMER MOTOR
- VDM - VALVE DRIVE MOTOR
- SW1 - TIMER HOMING SWITCH
- SW2 - TIMER PROGRAM SWITCH
- SW3 - VALVE HOMING SWITCH
- SW4 - VALVE STEP SWITCH
- SW5 - BRINE CAM SWITCH
- SW6 - AUXILIARY TIMER SWITCH
- THCAM - TIMER HOMING CAM
- TPCAM - TIMER PROGRAM CAM
- HCAM - VALVE HOMING CAM
- SCAM - VALVE STEP CAM
- BVCAM - BRINE VALVE CAM

NOTE:
TWO TANK INTERLOCKED SINGLE REMOTE METER SERIES REGENERATION.
ONLY ONE TANK IN REGENERATION THE OTHER IN SERVICE.
LEAD VALVE REGENERATES FIRST, FOLLOWED IMMEDIATELY BY LAG VALVE.

REMOTE METER WIRING

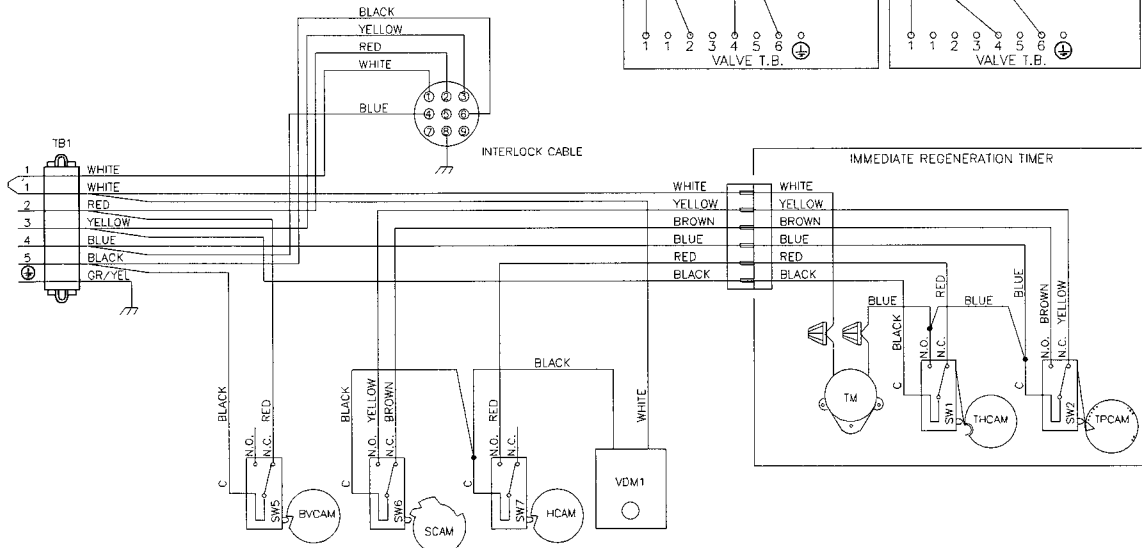
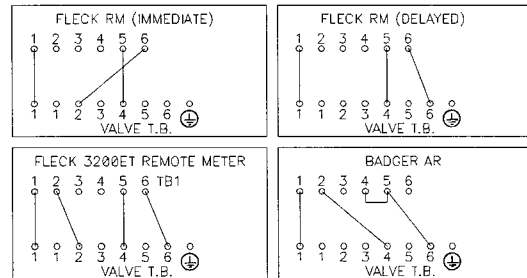

- TM - TIMER MOTOR
- VDM1 - VALVE DRIVE MOTOR
- SW1 - TIMER HOMING SWITCH
- SW2 - TIMER PROGRAM SWITCH
- SW3 - VALVE HOMING SWITCH
- SW4 - VALVE STEP SWITCH
- SW5 - BRINE CAM SWITCH
- SW6 - AUXILIARY TIMER SWITCH
- THCAM - TIMER HOMING CAM
- TPCAM - TIMER PROGRAM CAM
- HCAM - VALVE HOMING CAM
- SCAM - VALVE STEP CAM
- BVCAM - BRINE VALVE CAM

3150 24V/120V System #7

Valve Wiring

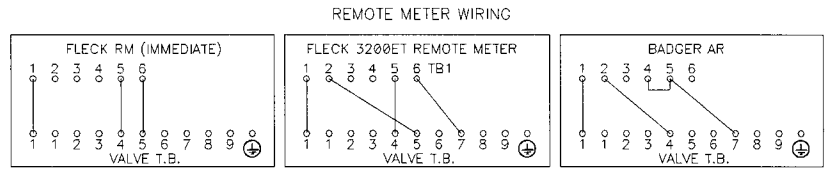
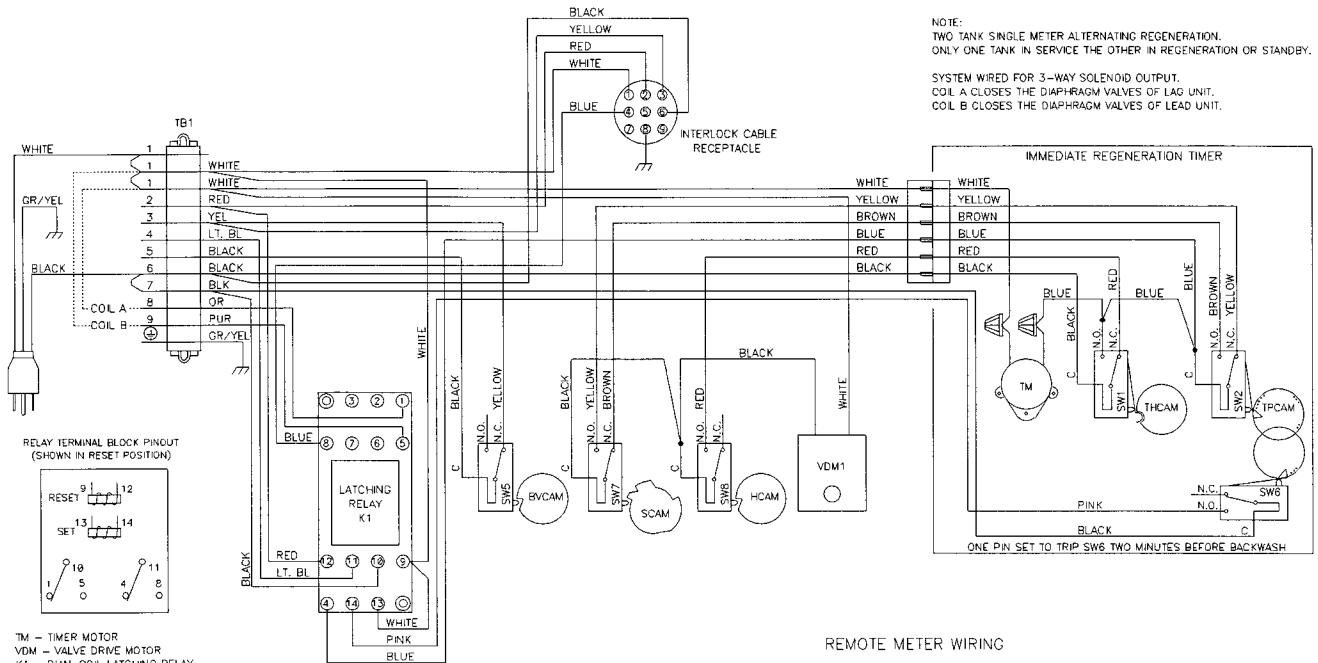

- TM - TIMER MOTOR
- VDM - VALVE DRIVE MOTOR
- K1 - DUAL COIL LATCHING RELAY
- 24V P/N 17818
- 120V P/N 16887
- SW1 - TIMER HOMING SWITCH
- SW2 - TIMER PROGRAM SWITCH
- SW3 - VALVE HOMING SWITCH
- SW4 - VALVE STEP SWITCH
- SW5 - BRINE CAM SWITCH
- SW6 - TIMER AUXILIARY SWITCH
- THCAM - TIMER HOMING CAM
- TPCAM - TIMER PROGRAM CAM
- HCAM - VALVE HOMING CAM
- SCAM - VALVE STEP CAM
- BVCAM - BRINE VALVE CAM

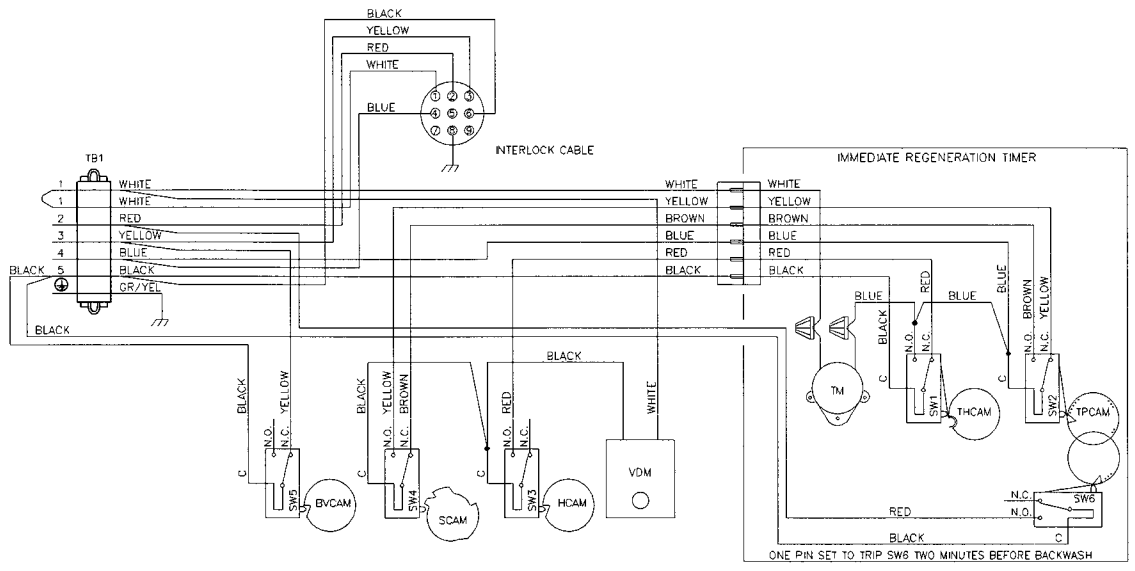

- TM - TIMER MOTOR
- VDM - VALVE DRIVE MOTOR
- SW1 - TIMER HOMING SWITCH
- SW2 - TIMER PROGRAM SWITCH
- SW3 - VALVE HOMING SWITCH
- SW4 - VALVE STEP SWITCH
- SW5 - BRINE CAM SWITCH
- SW6 - TIMER AUXILIARY SWITCH
- THCAM - TIMER HOMING CAM
- TPCAM - TIMER PROGRAM CAM
- HCAM - VALVE HOMING CAM
- SCAM - VALVE STEP CAM
- BVCAM - BRINE VALVE CAM

3150 230V System #7

Valve Wiring

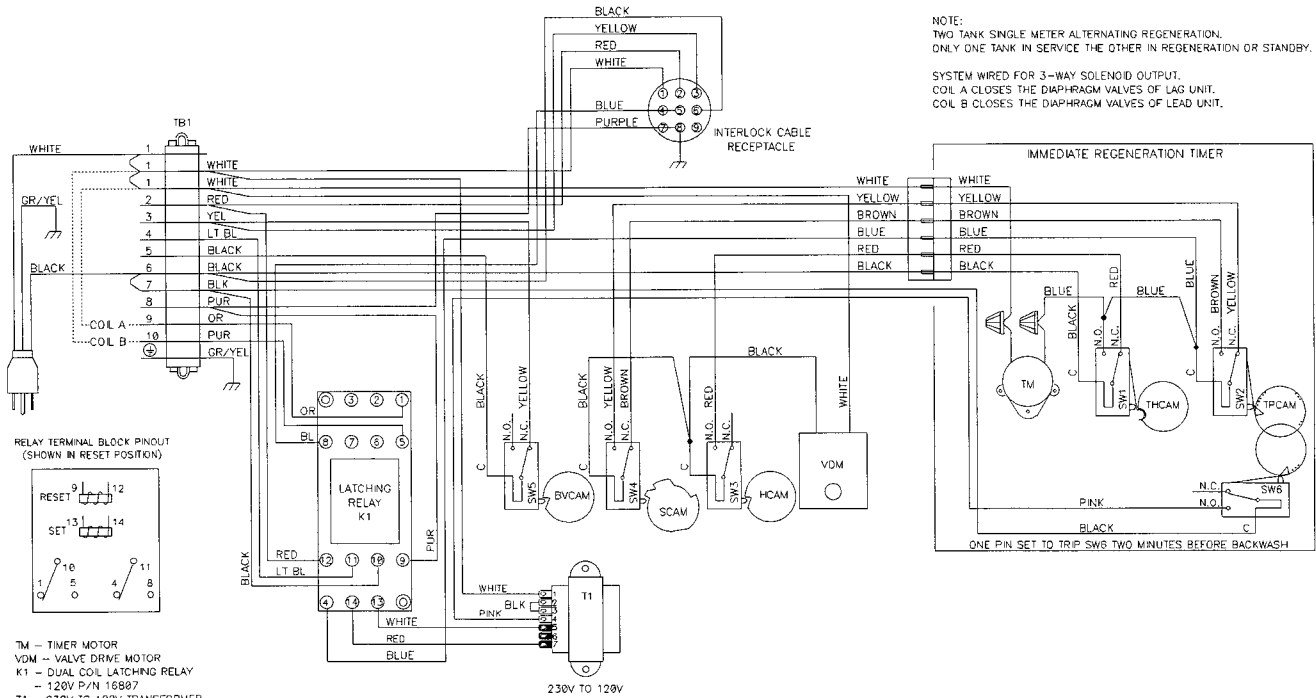

REMOTE METER WIRING

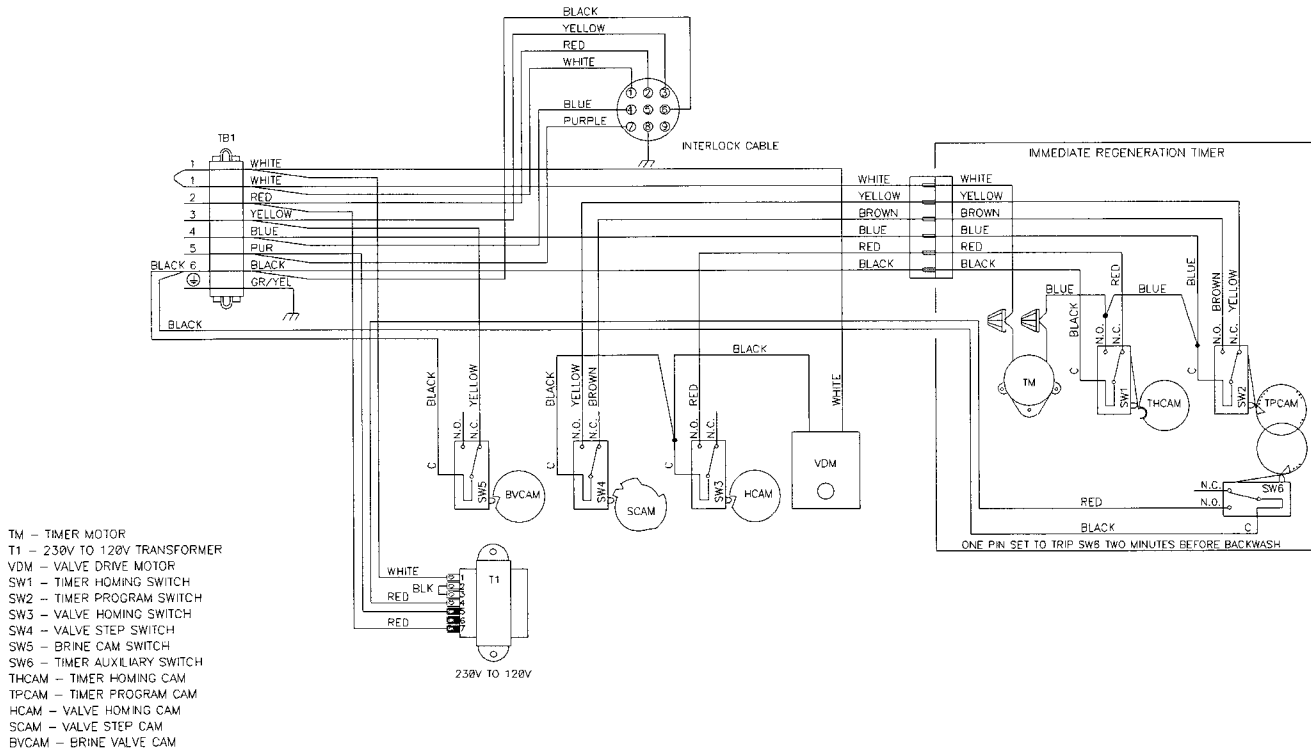
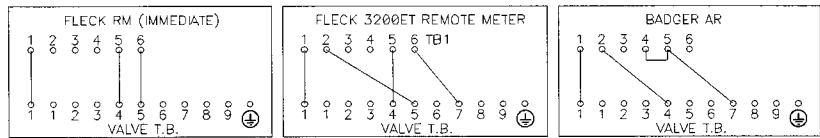

MODEL 3150

System #4 - Typical Single Tank Installation With Optional Meter

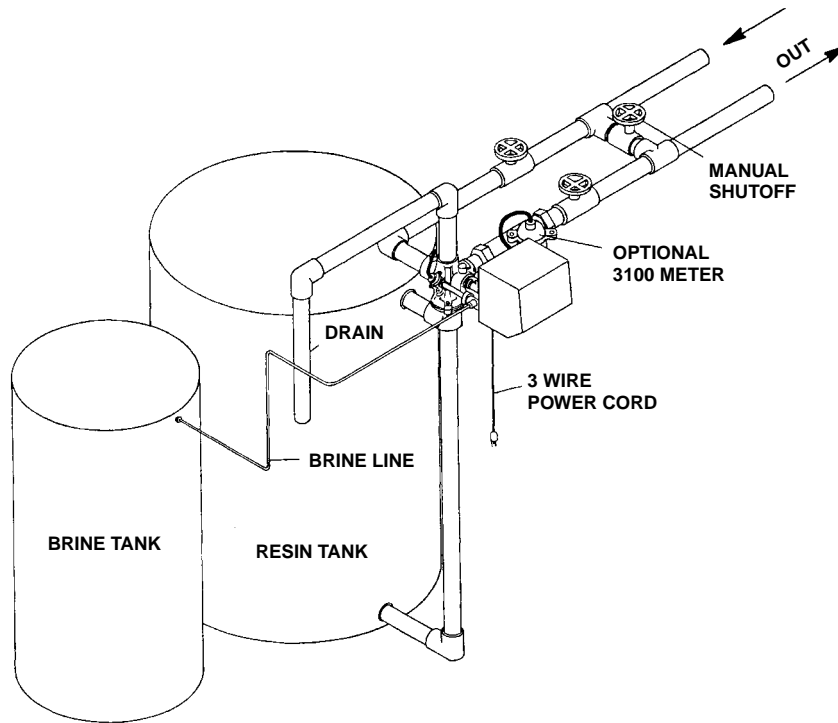

System #5 Interlock - Typical Twin Tank Installation with Optional Meter Interlock and No Hard Water Bypass

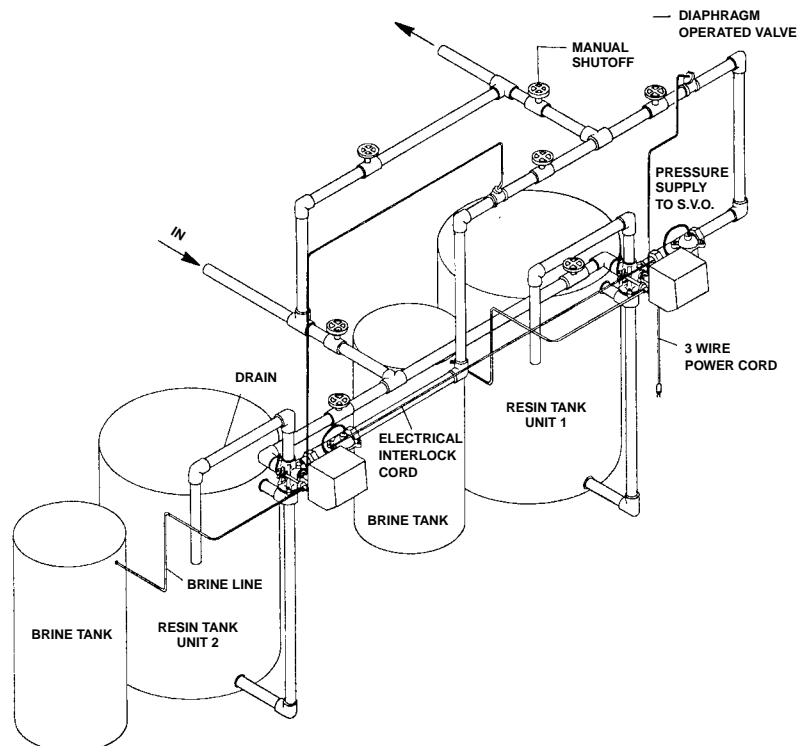

MODEL 3150

System #6 - Twin Series Regeneration Installation with a Remote Meter

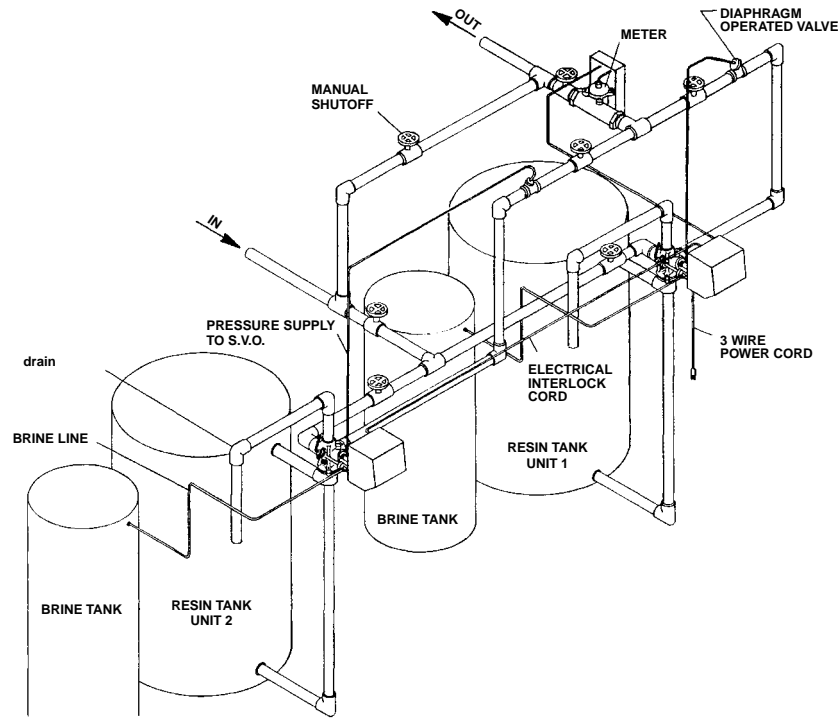

System #7 - Twin Alternator Installation with a Remote Meter

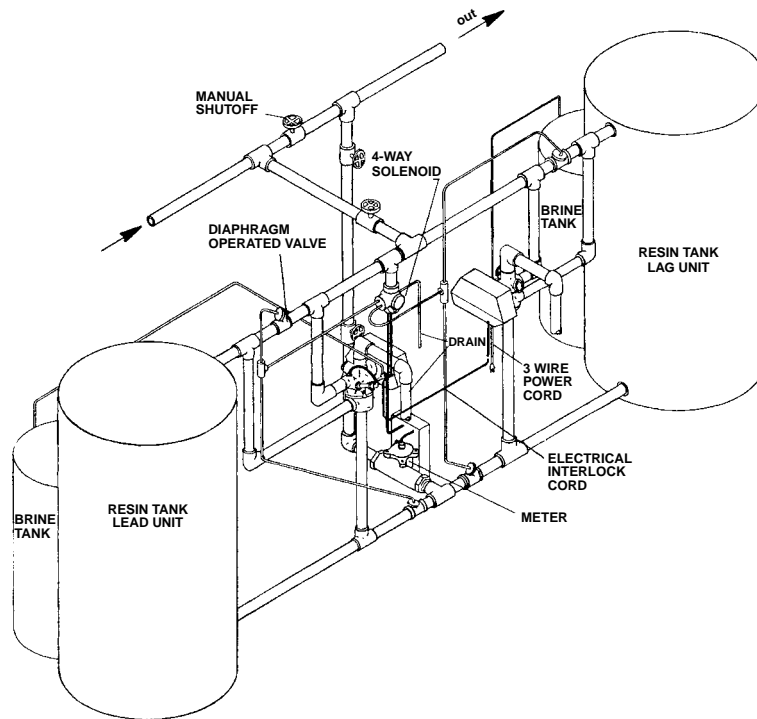

MODEL 3150 Downflow

Flow Data & Injector Draw Rates

3150 VALVE SIDE MOUNT & TOP MOUNT

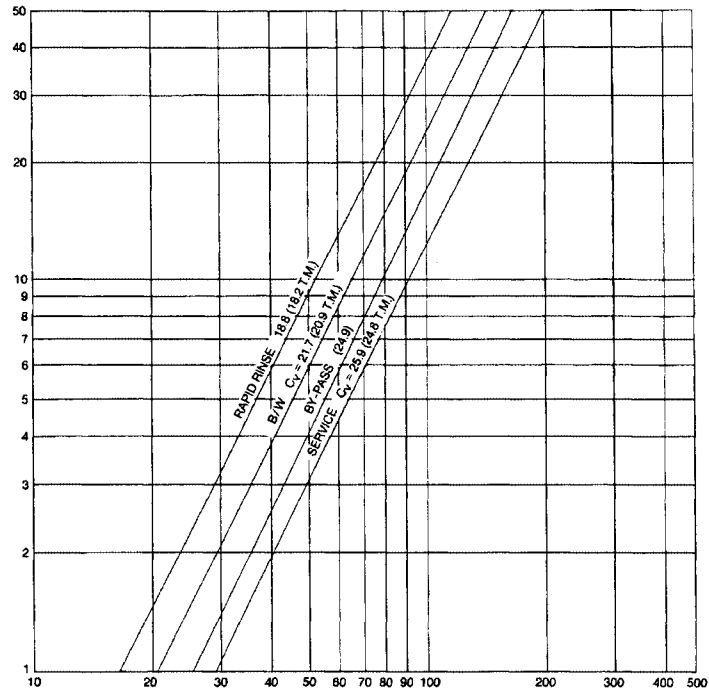

3150 ON EMPTY TANK

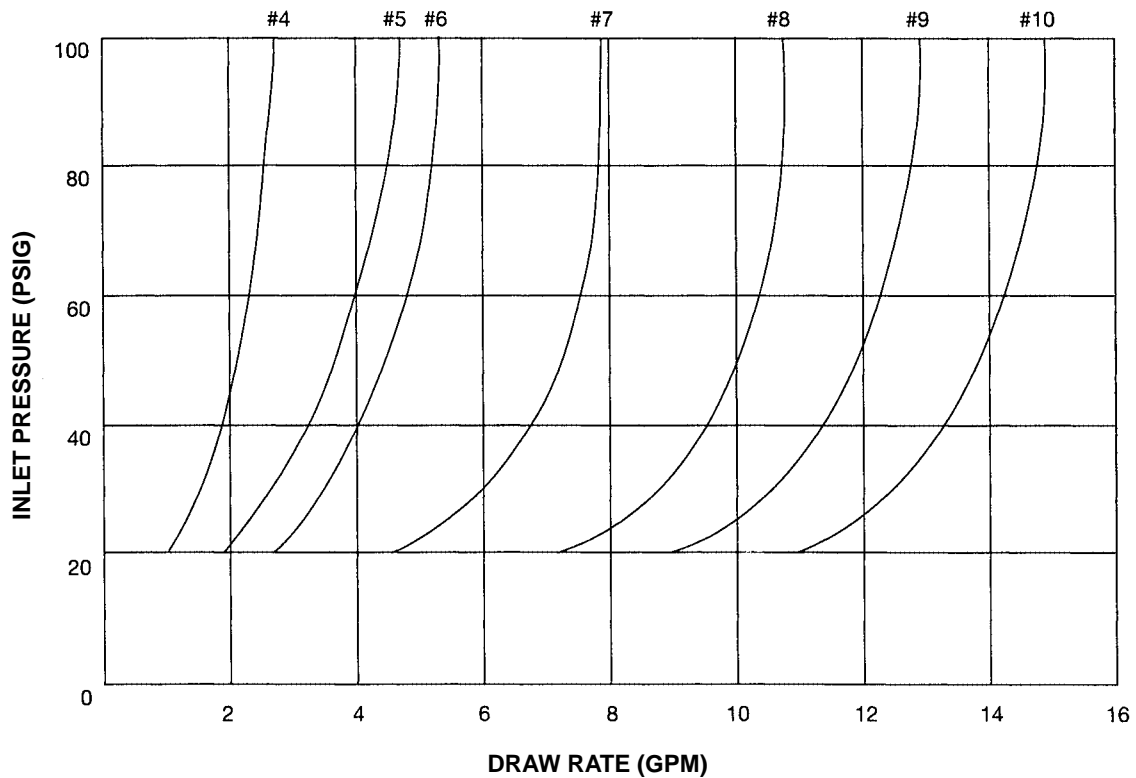

MODEL 3150 Downflow

* Typical Timer Settings

Tank Dia. Volume of Resin	B/W Rate-GPM	B/W Time Min.	1800 Inj. Size	Brine and Slow Rinse Time-Minutes									Fast Rinse Time	Brine Refill Rate GPM	Brine Tank Refill Time-Minutes		
				@ 6# Per Ft ³			@ 10# Per Ft ³			@ 15# Per Ft ³					@ 6# Per Ft ³	@ 10# Per Ft ³	@ 15# Per Ft ³
				35 PSI	60 PSI	90 PSI	35 PSI	60 PSI	90 PSI	35 PSI	60 PSI	90 PSI					
24" 10 Ft ³	15	10	4	42	30	26	68	50	46	102	76	64	10	2	6	16	26
30" 15 Ft ³	25	10	5	36	26	24	62	42	40	96	68	64	10	5	6	10	16
36" 20 Ft ³	35	10	6	34	28	28	58	48	48	84	68	68	10	5	8	14	20
42" 30 Ft ³	50	10	7	36	26	26	58	44	44	92	70	70	10	10	6	10	16
48" 42 Ft ³	70	10	8	34	34	34	56	56	56	76	76	76	10	15	6	10	14
54" 55 Ft ³	80	10	9	40	34	34	60	50	50	90	76	76	10	15	8	12	18
60" 70 Ft ³	100	10	10	46	36	34	68	54	52	102	80	78	10	20	8	12	18

WITH MODEL 2350 SAFETY BRINE VALVE

48" 42 Ft ³	70	10	8	34	34	34	56	56	56	76	76	76	10	10	9	16	22
54" 55 Ft ³	80	10	9	40	34	34	60	50	50	90	76	76	10	10	12	18	28
60" 70 Ft ³	100	10	10	46	36	34	68	54	52	102	80	78	10	10	16	24	36

MODEL 3150 Downflow

Service Assemblies

60036-02 1800 Brine Valve
See Illustration Page 10

- 1 11772 Spring
- 1 11774 Retaining Ring
- 1 18713 Brine Valve Body
- 1 16497-01 Brine Stem Assembly
- 1 16498-01 Stem Guide Assembly
- 1 18879 O-Ring

60277 1800 Injector Assembly
See Illustration Page 10

- 4 12473 Screw - Hex Hd.
- 1 15127 Injector Throat - Specify Size
- 1 15128 Injector Nozzle - Specify Size
- 2 15246 O-Ring - 116
- 1 16340 Injector Body
- 1 16341-01 Injector Cover

60106-00 3150 Piston Assembly
See Illustration Page 6

- 1 14818 Clip Piston Rod
- 1 14922 O-Ring - 035
- 1 16130 Piston
- 1 15125 Piston Rod
- 1 16398-01 End Plug Assembly White

60113-01 3150 No Hard Water Piston Assembly
See Illustration Page 6

- 1 16398-01 End Plug Assy
- 1 19611-01 Piston Assy, NHWB-P
- 1 19708 Piston Rod
- 1 14818 Clip Piston Rod

60131 3150 Seal Kit
See Illustration Page 6

- 2 10368 Spacer
- 5 10369 Spacer - Port
- 8 11720 Seal

60057-01 3150 Drive Motor Assembly - 115 V.
See Illustration Page 8

- 4 10302 Insulator - Switch
- 3 10872 Screw - Hex Hd.
- 1 11080 Screw - Flat Hd.
- 3 10218 Switch
- 2 12660 Nut 10-24
- 2 17567 Screw - Hex Hd.
- 1 15120 Bracket - Motor Mounting
- 1 16044 Drive Motor - 115V.
- 1 16052 Bushing
- 1 17797 Bracket - Switch Mounting
- 2 16055 Stand-Off
- 2 12624 Screw - Pan Hd.
- 2 16131 Spacer

60150-3150 3150 SVO Assembly
For Parts Breakdown
See Page 12

60393 2" Meter Assembly - Std. Range
For Parts Breakdown
See Page 13

60394 2" Meter Assembly - Ext. Range

